



3615 HO (Aust) GreenSmart™ 2 Fireplace

- Operation
- Maintenance



AS/NZS 5263.1.3 GMK10166
IAPMO-R&T OCEANA

WARNING: If the information in these instructions is not followed exactly, a fire or explosion may result causing property damage, personal injury or loss of life.

- DO NOT PLACE ARTICLES ON OR AGAINST THIS APPLIANCE.
- DO NOT USE OR STORE FLAMMABLE MATERIALS NEAR THIS APPLIANCE.
- DO NOT SPRAY AEROSOLS IN THE VICINITY OF THIS APPLIANCE WHILE IT IS IN OPERATION.
- DO NOT MODIFY THIS APPLIANCE.
- Do not store or use gasoline or other flammable vapors and liquids in the vicinity of this or any other appliance.

WHAT TO DO IF YOU SMELL GAS

- Do not try to light any appliance.
- Do not touch any electrical switch; do not use any phone in your building.
- Immediately call gas supplier from a neighbor's phone. Follow the gas supplier's instructions.
- If you cannot reach your gas supplier, call the fire department.
- Installation and service must be performed by a qualified installer, service agency or the gas supplier.

This appliance may be installed in an aftermarket permanently located, manufactured home (USA only) or mobile home, where not prohibited by local codes.

This appliance is only for use with the type(s) of gas indicated on the rating plate. A conversion kit is supplied with the appliance.

WARNING



**HOT GLASS WILL
CAUSE BURNS.
DO NOT TOUCH GLASS
UNTIL COOLED.
NEVER ALLOW CHILDREN
TO TOUCH GLASS.**

Owner's Manual

Dragon Wholesaling Pty. Ltd.

Unit 4, 16 Lexington Drive

Bella Vista NSW 2153

Australia

Introduction

We welcome you as a new owner of a 3615 HO gas fireplace. This manual details operation and maintenance of this fireplace. Please familiarize yourself with the Owner's Manual before operating your heater and save the manual for future reference.

Important Information

No other 3615 HO gas fireplace has the same serial number as yours. The serial number is on the listing label that is chained to the gas control valve. This serial number may be needed in case you require service.

Model: 3615 HO Fireplace

Serial Number: _____

Purchase Date: _____

Purchased From: _____

Register your warranty online at:

lopi.com.au

Or, mail your warranty card to:

Dragon Wholesaling Pty. Ltd.
Unit 4, 16 Lexington Drive
Bella Vista NSW 2153
Australia

Save Your Bill of Sale.

To receive full warranty coverage, you will need to show evidence of the date you purchased your heater. Do not mail your Bill of Sale to us.

We suggest that you attach your Bill of Sale to this page so that you will have all the information you need in one place should the need for service or information occur.

Installation Warnings

- Installation requirements are printed in the 3615 HO GSR2 Installation Manual (part # 100-01368). All requirements in the installation manual must be met.
- Failure to follow all of the requirements may result in property damage, bodily injury, or even death.
- This heater must be installed by a qualified installer who has gone through a training program for the installation of direct vent gas appliances.
- This appliance must be installed in accordance with all local codes, if any; if not, follow ANSI Z223.1 and NFPA 54(88). In Australia follow AS/NZS 5601.1.
- In Manufactured or Mobile Homes must conform with Manufactured Home Construction and Safety Standard, Title 24 CFR, Part 3280, or, when such a standard is not applicable, the Standard for Manufactured Home Installations, ANSI/NCSCS A225.1. This appliance may be installed in Manufactured Housing only after the home is site located.
- The fireplace is designed to operate on natural gas, or propane (LP).
- All exhaust gases must be vented outside the structure of the living-area. Combustion air is drawn from outside the living-area structure.
- Notify your insurance company before hooking up this fireplace.

Table of Contents

Introduction	2	Mode Controls (continued).....	13
Important Information.....	2	Accent Light	13
Installation Warnings.....	2	Display Fahrenheit or Celsius	13
Table of Contents	3	Low Battery Indicator	13
Features	3	Transmitter Batteries	13
Heating Specifications.....	3	IFC Batteries	13
Before You Begin	6	Battery Replacement	14
Remote Control Warnings.....	6	Battery Box (inside fireplace).....	14
Remote Set-Up.....	7	Transmitter Battery Installation	14
Verify the Switch is on “REMOTE”	7	Power Outages.....	14
Synchronize the Transmitter to the IFC	7	Child-Proof Feature	15
Clearing the System Memory	7	Normal Operating Sounds	15
Starting the Heater for the First Time.....	8	Normal Operating Odors	15
Location of Controls	8	Yearly Service Procedure.....	16
Direct Operation	8	Accent Light Replacement.....	17
Continuous/Intermittent Pilot Switch	9	Glass Frame Removal and Installation.....	18
Switching from Intermittent (IPI) to		Crushed Glass Installation.....	20
Continuous Pilot (CPI)	9	Glass Cleaning	21
Remote Operation	10	Troubleshooting Table	22
Display Overview	10	Location of fuses	22
Listen for the “Beep”	10	Wiring Diagram	23
Manual On-Off / Smart Thermostat / Standard		Replacement Parts List	23
Thermostat.....	11	CONDITIONS & EXCLUSIONS	24
Mode Controls (Flame, Blower, Light).....	12	IF WARRANTY SERVICE IS NEEDED:	24
Flame Height.....	12	Index.....	26
Blower Speed	12		

Features

- Works During Power Outages (battery backup)
- GreenSmart™ Thermostat / Remote Control
- Contemporary Look
- Blower for Effective Heat Distribution
- Built-In Accent Light (night light)
- Standing or Intermittent (GreenSmart) Pilot
- Variable-Rate Heat Output
- Low Maintenance

Heating Specifications

	Natural Gas	Propane
Approximate Heating Capacity (in square meters)*	Up to 157	Up to 157
Maximum Input Per Hour (MJ/H)	34.82	34.82

* Heating capacity will vary with floor plan, insulation, and outside temperature.

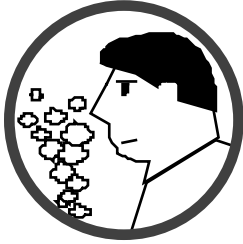
**IF YOU SMELL GAS:**

- * Do not light any appliance
- * Extinguish any open flame
- * Do not touch any electrical switch or plug or unplug anything
- * Open windows and vacate building
- * Call gas supplier from neighbor's house, if not reached, call fire department



This unit must be installed by a qualified installer to prevent the possibility of an explosion. Your dealer will know the requirements in your area and can inform you of those people considered qualified. The room heater should be inspected and cleaned before use and at least annually by a qualified service person. More frequent cleaning may be required due to excessive lint from carpeting, bedding material, etc.

The instructions in this manual must be strictly adhered to. Do not use makeshift methods or compromise in the installation. Improper installation will void the warranty and safety listing.

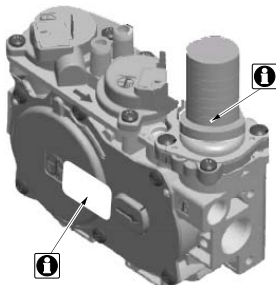

This heater is either approved for natural gas (NG) or for propane (LP). Burning the incorrect fuel will void the warranty and safety listing and may cause an extreme safety hazard. Direct questions about the type of fuel used to your dealer. Check for a label on the flame adjust knob on the gas control valve (this is the best place to check). You may also check for a label on the gas control valve body.



Contact your local building officials to obtain a permit and information on any installation restrictions or inspection requirements in your area. Notify your insurance company of this heater as well.



If the flame becomes sooty, dark orange in color, or extremely tall, do not operate the heater. Call your dealer and arrange for proper servicing.



It is imperative that control compartments, screens, or circulating air passageways of the heater be kept clean and free of obstructions. These areas provide the air necessary for safe operation.



Do not operate the heater if it is not operating properly in any fashion or if you are uncertain. Call your dealer for a full explanation of your heater and what to expect.



Do not store or use gasoline or other flammable liquids in the vicinity of this heater.



Do not operate if any portion of the heater was submerged in water or if any corrosion occurs. Immediately call a qualified service technician to inspect the appliance and to replace any part of the control system and any gas control that has been under water.



Do not place clothing or other flammable items on or near the heater. Because this heater can be controlled by a thermostat there is a possibility of the heater turning on and igniting any items placed on or near it.

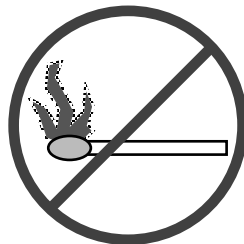

Light the heater using the built-in igniter. Do not use matches or any other external device to light your heater.

Allow the heater to cool before carrying out any maintenance or cleaning.



The viewing glass should be opened only for conducting service. Do not operate with cracked, broken, or removed glass.

Any safety screen or guard removed for servicing must be replaced prior to operating the heater.

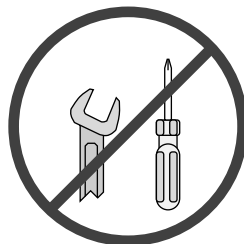

Never remove, replace, modify or substitute any part of the heater unless instructions are given in this manual. All other work must be done by a trained technician. Don't modify or replace orifices.



Operate the heater according to the instructions included in this manual.

If the main burners do not start correctly turn the gas off at the gas control valve and call your dealer for service.

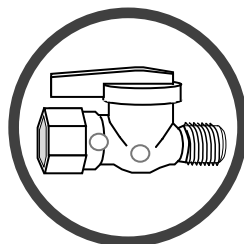

Instruct everyone in the house how to shut gas off to the appliance and at the gas main shutoff valve. The gas main shutoff valve is usually next to the gas meter or propane tank and requires a wrench to shut off.



This unit is not for use with solid fuel

Do not place anything inside the firebox (except the crushed glass).

If any component becomes damaged, replace with Travis Industries components.



Do not throw this manual away. This manual has important operating and maintenance instructions that you will need at a later time. Always follow the instructions in this manual.



Children and adults should be alerted to the hazards of high surface temperature and should stay away to avoid burns or clothing ignition. Young children should be supervised when they are in the same room as the heater.



Travis Industries, Inc. grants no warranty, implied or stated, for the installation or maintenance of your heater, and assumes no responsibility of any consequential damage(s).

Before You Begin

- Read this entire manual before you use your new fireplace (especially the section "Safety Precautions" on pages 4 & 5). Failure to follow the instructions may result in property damage, bodily injury, or even death.

Remote Control Warnings

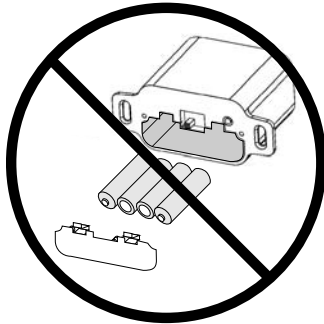

KEEP BATTERIES AND COVER INSTALLED AT ALL TIMES

The remote control system requires the batteries and battery cover to remain in place at all times. Once the batteries or cover are removed, the system may re-start in standing pilot mode. If this occurs when the heater is in Remote Mode, you will not be able to turn the heater off manually from the battery box.

If you need to replace dead batteries, make sure to **turn the appliance off** before removing the batteries.

NOTE: If the batteries go dead, the system will operate normally as long as household power is present.



The transmitter and IFC are radio frequency devices. Placing the transmitter in or near metal may severely reduce the signal range.



Turn off the main gas supply during appliance installation or maintenance or in case of remote control malfunction.

SAFETY WARNINGS:

- **DO NOT PLACE ARTICLES ON OR AGAINST THIS APPLIANCE.**
- **DO NOT USE OR STORE FLAMMABLE MATERIALS NEAR THIS APPLIANCE.**
- **DO NOT SPRAY AEROSOLS IN THE VICINITY OF THIS APPLIANCE WHILE IT IS IN OPERATION.**
- **DO NOT MODIFY THIS APPLIANCE.**
- **THIS INSTALLATION MUST CONFORM WITH THE FOLLOWING:**
 - Manufacturer's Installation instructions
 - Local Gas Fitting Regulations
 - Municipal Building Codes,
 - Refer to AS/NZS 5601.1 for Gas Installations.
 - S.A.A. Wiring Code
 - Local Electrical Regulations
 - Any other statutory regulations
- **NOT SUITABLE FOR MARINE USE.**
- **NOT INTENDED FOR FIREPLACE INSERT.**
- **APPLIANCES INCORPORATING A LIVE FUEL EFFECT, AND DESIGNED TO OPERATE WITH LUMINOUS FLAMES, MAY EXHIBIT SLIGHT CARBON DEPOSITION.**

Remote Set-Up

Verify the Switch is on “REMOTE”

To access the remote switch, remove the concealment cover and screen (see 18). Locate the heat shield and remove it (see illustration below). NOTE: the heat shield must be in place whenever the fireplace is in operation. The on/remote/off switch on the battery box may then be accessed. This switch must remain in the REMOTE position for the remote to operate.

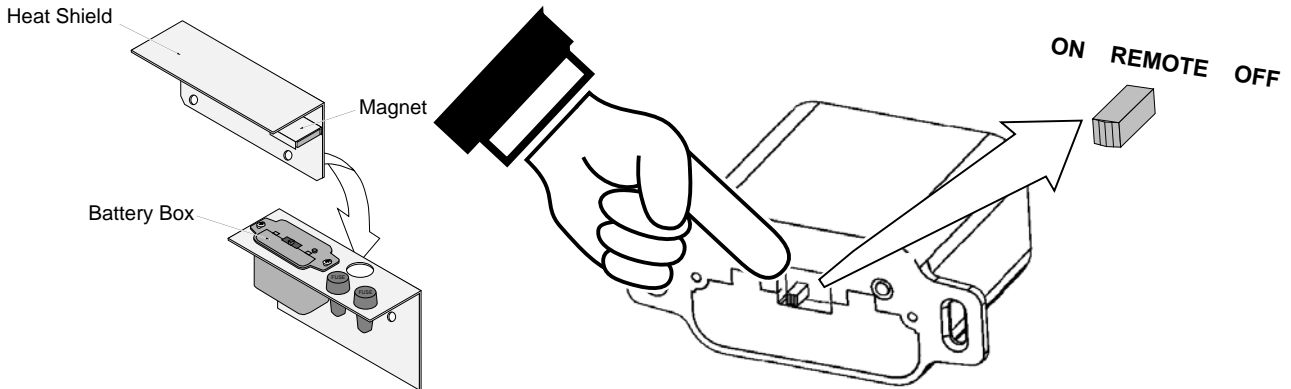

Synchronize the Transmitter to the IFC

The transmitter will need to be synchronized to the IFC (Integrated Fireplace Control) before the remote will work correctly. Synchronizing is done in the following two steps below (see below):

- Press the PRG (Program) button on the battery box (IFC will beep 3 times).
Press the “ON” button on the transmitter (IFC will beep 3 times).

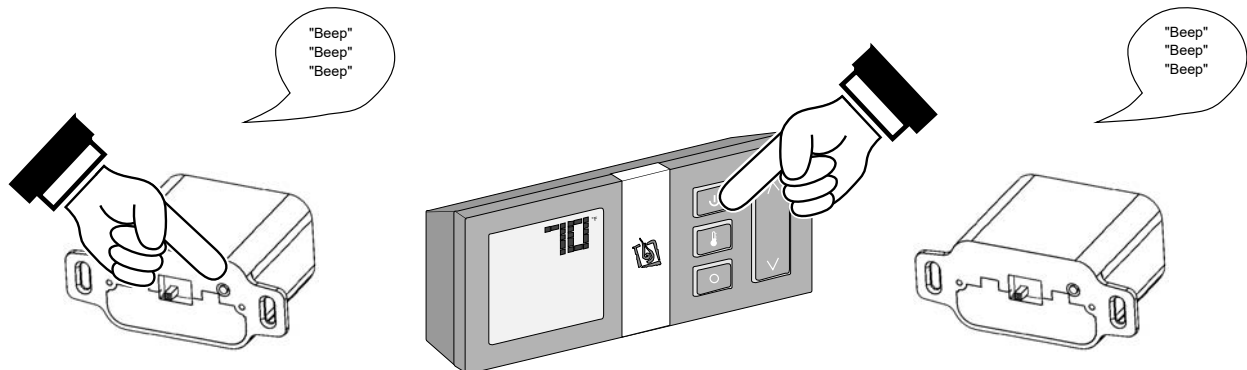

NOTE: If power is cut off to the IFC for an extended period of time, you may need to re-synchronize the remote.

Clearing the System Memory

This appliance uses an Integrated Fireplace Control (IFC) to store the unique code for the remote control. If you wish to clear the system memory, **MAKE SURE GAS IS TURNED OFF TO THE APPLIANCE** then press the PRG (Program) button for 10 seconds. The pilot will start to spark repeatedly, signifying all system memory has been cleared. The system will return to its original configuration – a remote will need to be synchronized; and the system will operate in Continuous Pilot mode.

Starting the Heater for the First Time

- Burn the heater at a low setting with the blower off for an extended period (up to 48 hours). This will cure the painted surfaces. **Fumes** from the paint curing and oil burning off the steel will occur. This is normal. We recommend opening a window to vent the room.
- **Condensation** may appear on the glass each time you start the heater - this is normal.
- **Blue Flames** will occur on the heater when it first comes on. After fifteen minutes the flames will turn a more realistic yellow and orange color.
- Verify the batteries are installed (see page 14).

Location of Controls

Most features will be controlled by the included remote.

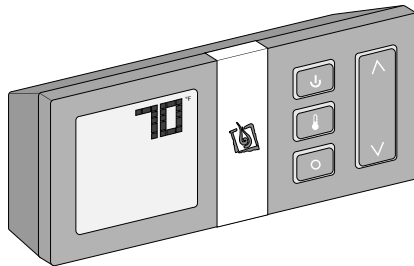

Direct Operation

We recommend using the remote to operate the fireplace. If you do need to operate the fireplace directly, remove the concealment cover and screen (see page 18). Locate the heat shield and remove it (see illustration below). **NOTE:** the heat shield must be in place whenever the fireplace is in operation. The on/remote/off switch on the battery box may then be accessed.

ON – Burner turns on (regardless of transmitter settings).

OFF – Burner turns off (regardless of transmitter settings).

REMOTE – Burner is controlled by the transmitter.

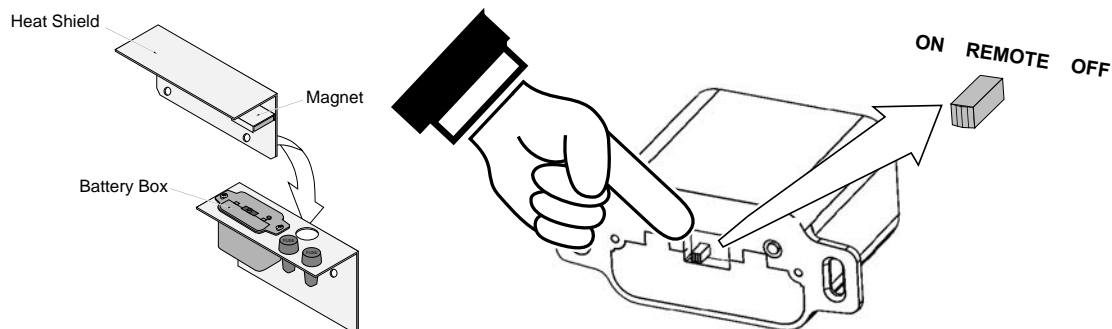

NOTE: When the battery holder switch is turned to ON or OFF, the mode settings (Flame Height, etc.) will remain in the same state as before the switch was moved (i.e.: the IFC “remembers” the last setting). If you wish to adjust the mode settings use the transmitter mode button to adjust the settings. The thermostat and burner on/off operating functions will not work on the transmitter.

Continuous/Intermittent Pilot Switch

This heater may run with the pilot continuously running or in Intermittent mode. For most homeowners, Intermittent mode is preferable (this saves fuel, doesn't give off un-needed heat). However, in some situations the homeowner may prefer to switch the heater to Continuous Pilot mode. The most typical reasons for switching to Continuous Pilot are:

- **Very Cold Conditions** – In very cold conditions you may notice that the burner does not light quickly, and the flames lift off the burner. If this is situation, we recommend you switch to continuous pilot. This will create a slight draft in the vent, allowing for the burner to light quickly and draft correctly.
- **Excessive Condensation on Glass After Startup** – Certain installations may encounter excessive fogging on the window after startup (not just the first time the heater was started). This is an aesthetic condition that may be remedied by switching the heater to continuous pilot.
- **Cold Glass or Heater Front** – In very cold conditions you may notice that the heater front and glass become very cold. To remedy this, switch the heater to continuous pilot.
- **Frequent On / Off Operation** – If you are frequently turning the heater on and off, you may wish to leave it in continuous pilot. This allows the burner to turn on more quickly, without pilot ignition delay.

Switching from Intermittent (IPI) to Continuous Pilot (CPI)

The pilot mode on this appliance is adjusted using the remote. With the remote in the off position (thermostat off, manual off), follow the directions below to adjust the pilot mode.

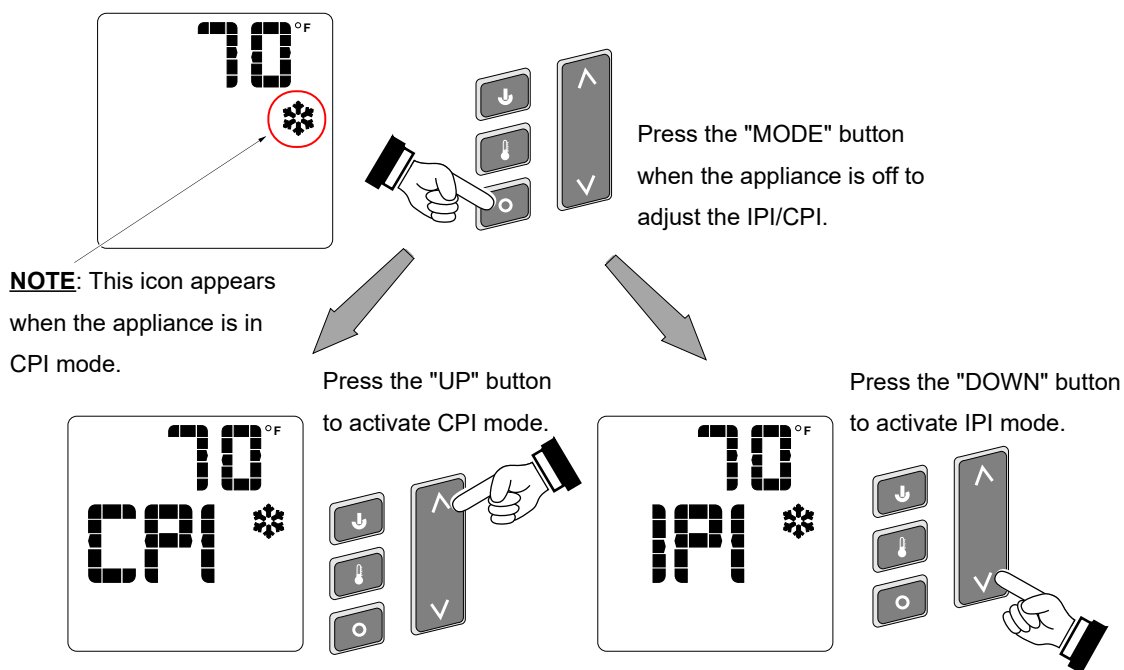

Remote Operation

When the switch on the battery holder is set to "REMOTE" the transmitter operates the fireplace. Once you understand how the transmitter works, you will be able to operate your fireplace quickly and easily.

Display Overview

The transmitter display has four main sections (see below).

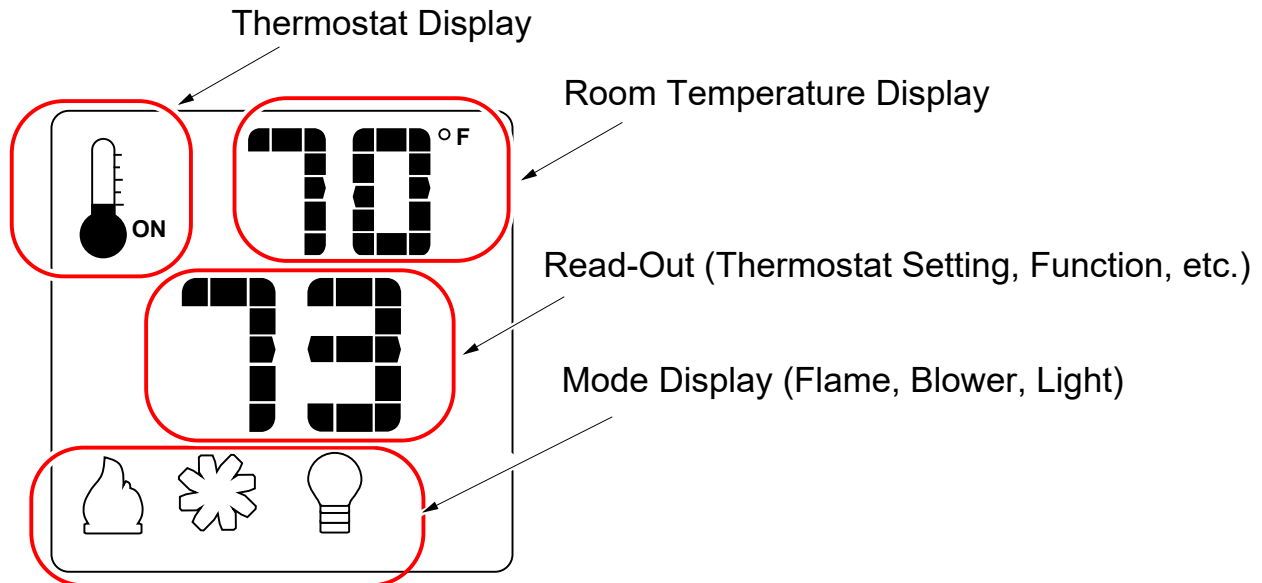

Listen for the "Beep"

Each time you press a button on the transmitter that controls the fireplace, a "beep" will sound from the IFC. When you change thermostat target settings the IFC will not beep.

NOTE: When the batteries start to get low, the IFC will beep twice whenever a button is pressed. When the batteries are nearly depleted, the IFC will no longer beep. See "IFC Batteries" on page 13).

Manual On-Off / Smart Thermostat / Standard Thermostat

Use the thermostat button to cycle through the three thermostat settings (see below).

Look here for the thermostat setting.

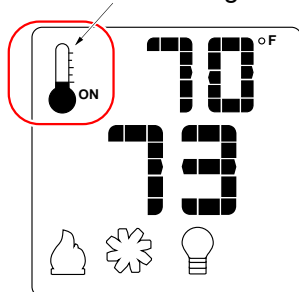

Press the thermostat button to cycle through the thermostat settings.

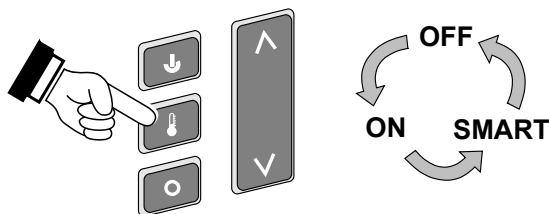

- MANUAL ON/OFF** – The burner will turn on and off using the remote (see below). Press the On/Off button to control the burner. When off, the display will only show the current temperature.

When in manual setting, the word "OFF" will appear here.

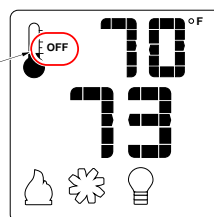

- SMART THERMOSTAT** – While in Smart Thermostat mode, the transmitter will control the burner to achieve the target temperature (see below). Flame height will be adjusted up or down to allow operation without turning the burner on and off (also called "smart modulation"). To adjust the target temperature, press the UP and DOWN buttons until a suitable temperature is achieved.

When in smart thermostat setting, the word "SMART" will appear here.

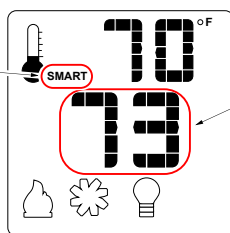

This is the target temperature on the read-out. Use the up or down buttons to adjust the target temperature.

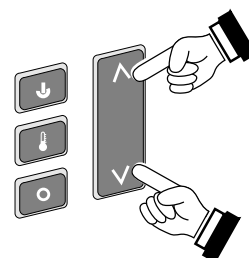

- STANDARD THERMOSTAT** - While in Standard Thermostat mode, the transmitter will turn the burner on and off to achieve the target temperature (see below). To adjust the target temperature, press the up and down buttons until a suitable temperature is achieved.

When in standard thermostat setting, the word "ON" will appear here.

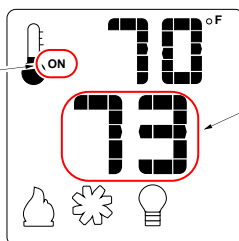

This is the target temperature on the read-out. Use the up or down buttons to adjust the target temperature.

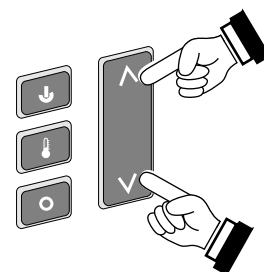

NOTE: If the transmitter batteries go dead while in thermostat setting (standard or smart), the appliance will shut off after approximately 24 hours.

Mode Controls (Flame, Blower, Light)

Press the Mode button to cycle through the four mode controls (see below).

Press the mode button to cycle through the mode settings.

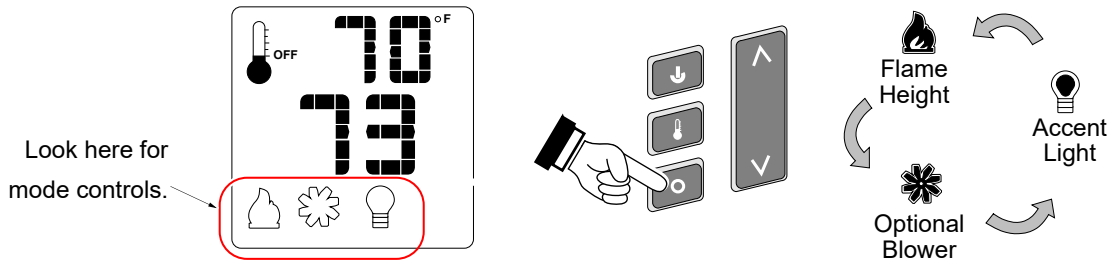

Flame Height

Flame height may be controlled using the UP and DOWN buttons when in Flame Height Mode (see below). The center display will display the 7 settings, from “OFF” to “HI” for full on.

NOTE: Flame height may not be adjusted if operating in Smart Thermostat mode.

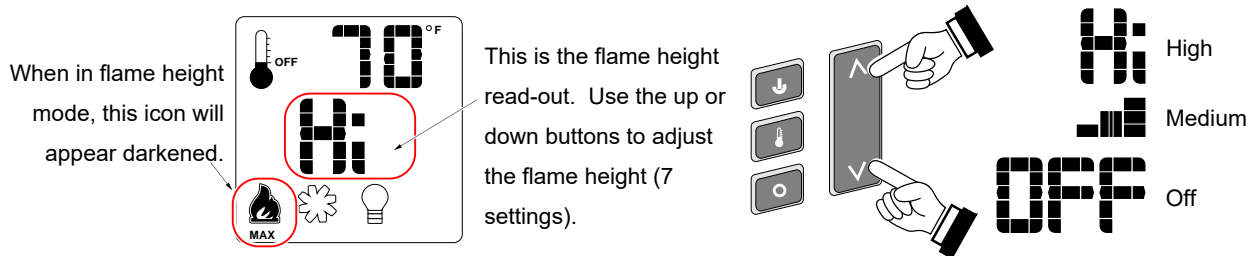

Blower Speed

The blower may be controlled using the up and down buttons when in Blower Speed mode (see below). The center display will display the 7 settings, from “OFF” to “HI” for full on.

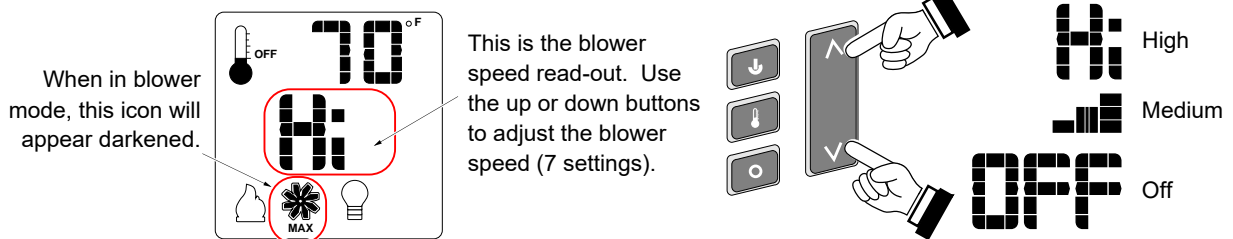

MANUAL MODE – BLOWER OPERATION



When in Manual mode the blower will remain on, even if the burner is turned off and the heater cools.

Either manually turn the blower off, or turn off the heater by pressing the On/Off button.

Mode Controls (continued)

Accent Light

The Accent Light (night light) inside the heater may be turned on and off using the up and down buttons when in Accent Light mode (see below). The center display will display the 7 settings, from “OFF” to “HI” for full on.

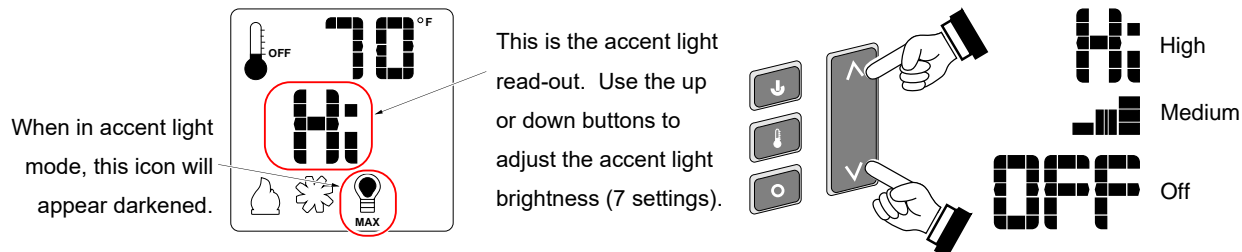

HINT: If you wish to leave the accent light on while turning the burner off, adjust the Flame Height setting to “OFF” (see above).

Display Fahrenheit or Celsius

With the system in the “OFF” position, press both the MODE and THERMOSTAT buttons simultaneously to toggle between Fahrenheit (F) and Celsius (C).

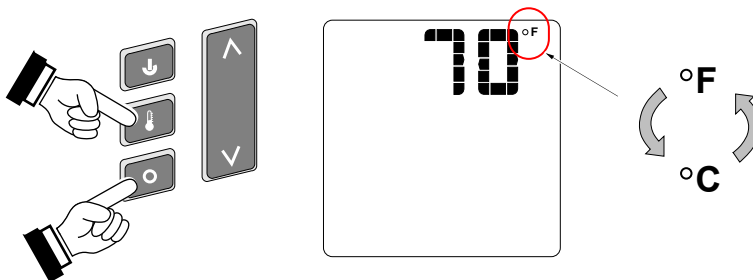

Low Battery Indicator

Transmitter Batteries

The transmitter has a battery-level indicator. When it indicates low battery voltage (see below), install three new AAA alkaline batteries into the transmitter (see “Battery ” on page 14).

Low Battery Indicator

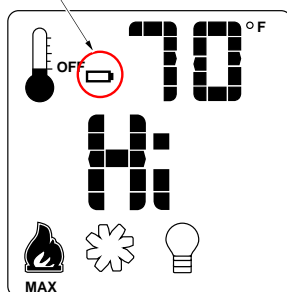

IFC Batteries

The IFC (Integrated Fireplace Control) will “beep” twice when a transmitter button is pressed when the batteries are low. Install four new AA alkaline batteries into the battery box when this occurs (see “Battery ” on page 14). In applications where the appliance is required to provide heat, we recommend replacing the batteries before each heating season.

Battery Replacement

Battery Box (inside fireplace)

Install four AA batteries into the battery box (see below). These batteries act as a power backup in case the household (AC) current goes out.

To access the battery box, remove the concealment cover and screen (see page 18). Locate the heat shield and remove it (see illustration below). NOTE: the heat shield must be in place whenever the fireplace is in operation. The battery box may then be accessed.

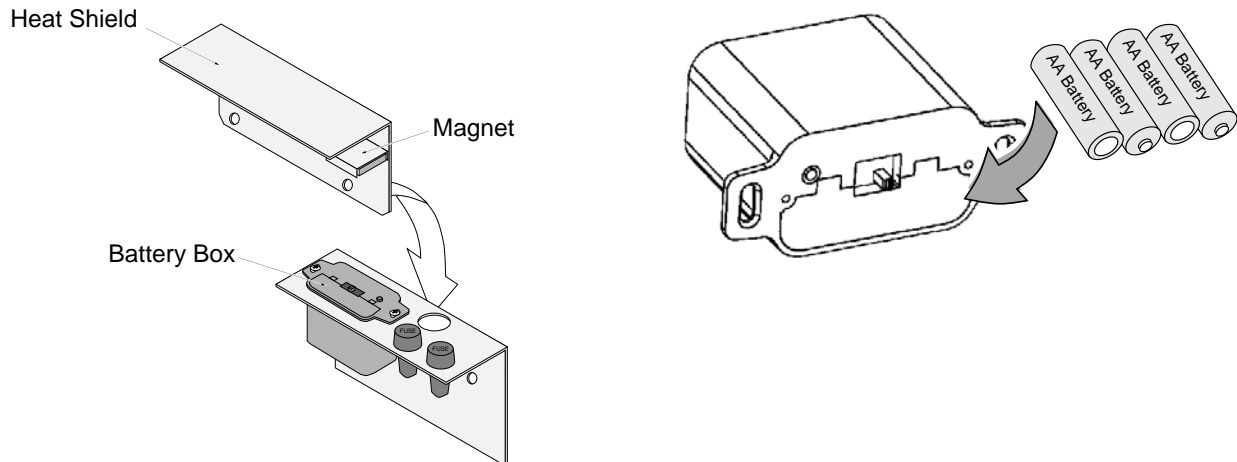

Transmitter Battery Installation

Install the three included AAA batteries into the remote.

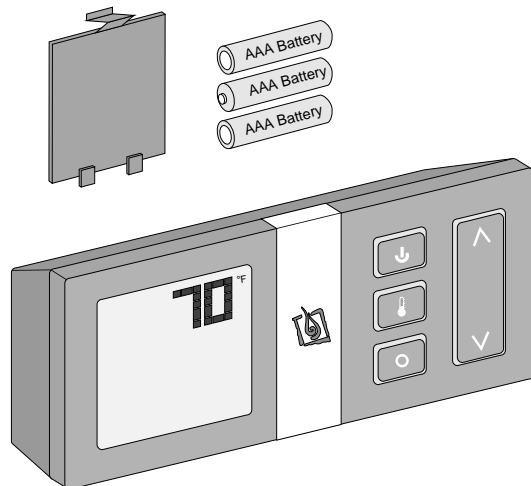

Power Outages

The remote will work if household current (AC power) is disconnected. The batteries inside the battery box will continue to power the heater but the accent light and blower will not operate.

Child-Proof Feature

The child-proof feature disables the control buttons, preventing unwanted use of the remote.

- Press both the MODE and UP buttons simultaneously to turn this feature on or off.

HINT: This feature is especially useful while using the thermostat setting.

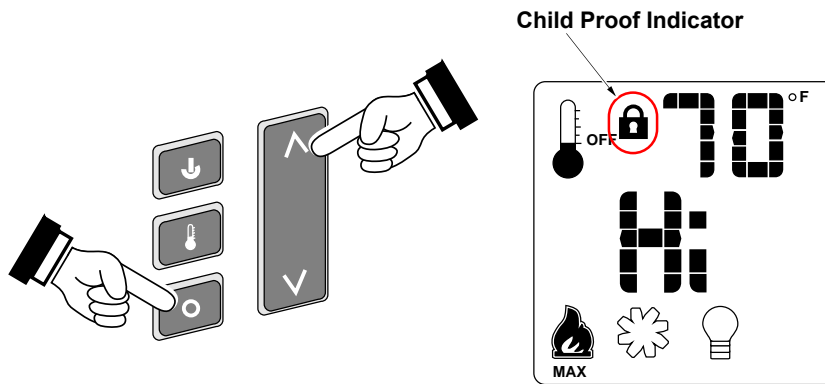

Normal Operating Sounds

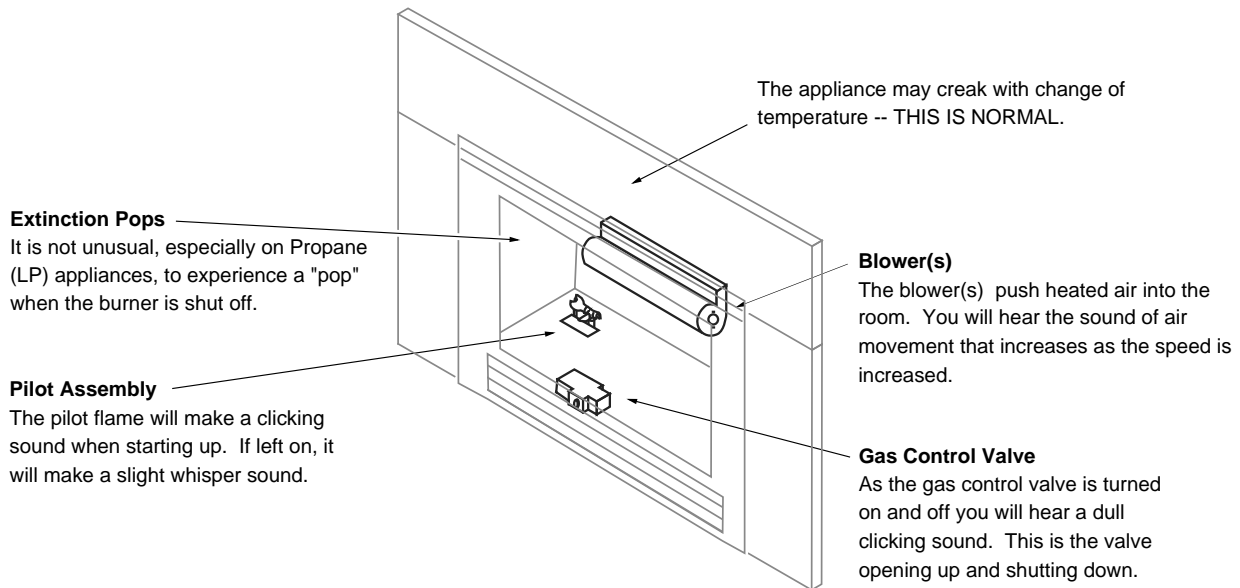

Normal Operating Odors

This appliance has several areas that reach high temperatures. Dust or other particles on these areas may burn and create an odor. This is normal during startup. You may notice the smell is more acute if the appliance was left idle for a long period.

Yearly Service Procedure



Failure to inspect and maintain the heater may lead to improper combustion and a potentially dangerous situation. We recommend the following procedures be done by a qualified technician.

1. Turn the pilot flame to continuous. It should touch approximately 3/8" of the top of the flame sensor. If it does not, contact your dealer for service.
2. Shut off gas to the heater and let it cool for 15 minutes. Remove the glass (see page 16). Glass may be cleaned with glass cleaner and a soft cloth (do not use abrasive cleaners).
3. Remove the crushed glass. Check the media for sooting. A small amount of soot along the bottom of the media is normal. If excessive sooting is found, the heater will require adjustment. Contact your dealer for service.
4. Inspect the burner and remove any debris.
 - Make sure the burner is not warped, cracked, or damaged.
 - Check the firebox and area around the pilot to make sure there is no warping or damage.
 - If any problem is found, discontinue use and contact your dealer for service.
5. Re-install the crushed glass. Clean and replace the glass. If the glass is damaged, replace it. Make sure the gasket along the perimeter of the glass contacts the face of the firebox and forms an air-tight seal. If it does not, re-align or replace the gasket to ensure an air-tight seal.
6. Inspect the area behind the access door. Clean if necessary. Check the gas control valve and the gas lines. If damage is found, discontinue use and contact your dealer for service. Clean the air channels, ducts, and blower (if applicable).
7. Start the main burner. Inspect the main burner and pilot flame. After 15 minutes the flames should be orange/yellow and not touch the top of the firebox. If the pilot or main burners do not burn correctly, contact your dealer for service. Monitor blower operation.
8. Remove any debris or vegetation near the vent termination. Contact your dealer if any sooting or deterioration is found near the vent termination. The venting system should be examined by a qualified agency.

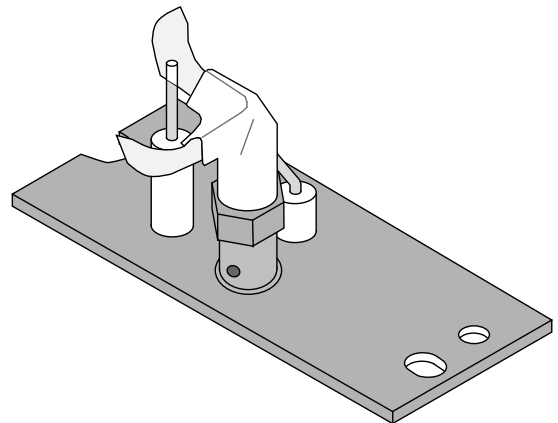

Accent Light Replacement

The accent lights in your heater provide additional lighting. The bulbs will burn out over time. To replace, follow the directions below:

- Shut off gas to the heater and let it cool for 15 minutes.
- Remove the glass frame (page 18) and crushed glass (page 20). Remove the glass tray (it is held in place with 6 screws - 1/4" nutdriver – see photos below).



- Replace the halogen bulbs with the following bulbs:



35 Watt 240 Volt T4 Halogen Bulb (G6.35 Base)

NOTE: Take care to not touch the bulbs with your fingers – use foam packing or a paper towel to handle the bulbs,

Glass Frame Removal and Installation



Do not remove the glass frame with the screen attached – it will not disengage correctly and may damage the screen.



The appliance must be completely cool before removing the glass.



Do not strike or slam the glass.



Warning: Do not operate appliance with the glass front removed, cracked or broken. Replacement of the glass should be done by a licensed or qualified service person.

GLASS FRAME TOOL

The glass frame tool is shipped inside the fireplace, under the concealment cover. The first time it is used you may need to loosen the screw (1/4" wrench). The tool is accessed after removing the screen.



NOTE: Replace the tool in this location after use.

- Remove the concealment cover and place aside. It has two holes that aid in removal.



- Remove the three screws holding the screen in place (1/4" nutdriver- magnetic driver recommended). Then pivot the screen down slightly until the clips on the bottom disengage from the glass frame.



- Use the glass tool to unlatch the glass frame. Remove the glass frame. The glass frame is held in place with four tabs inserted into four slots at the bottom of the firebox opening.

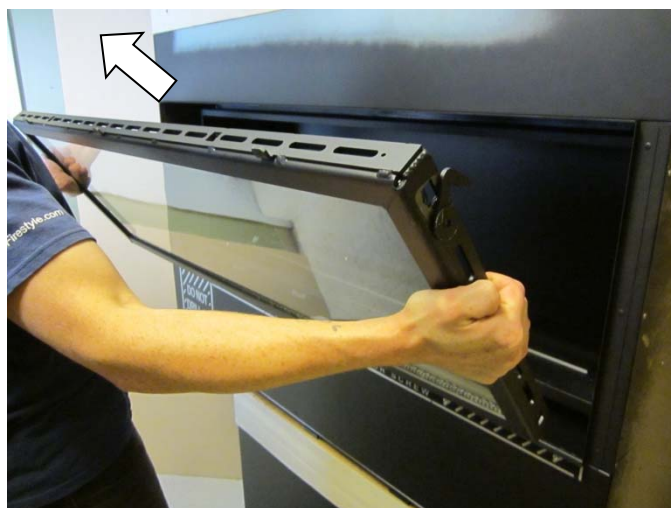
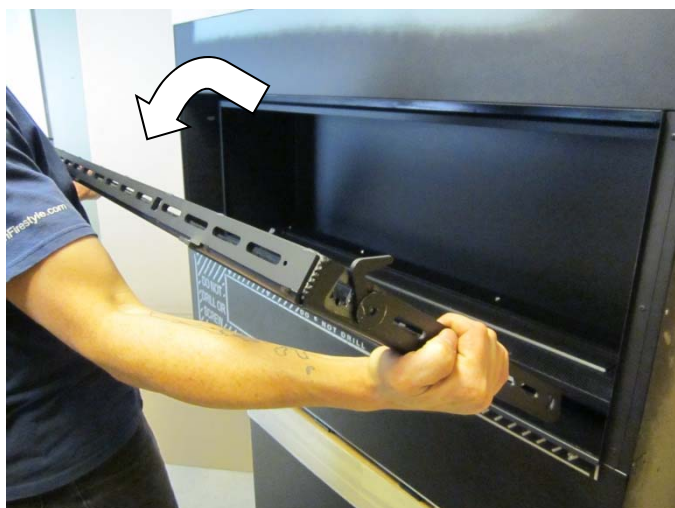
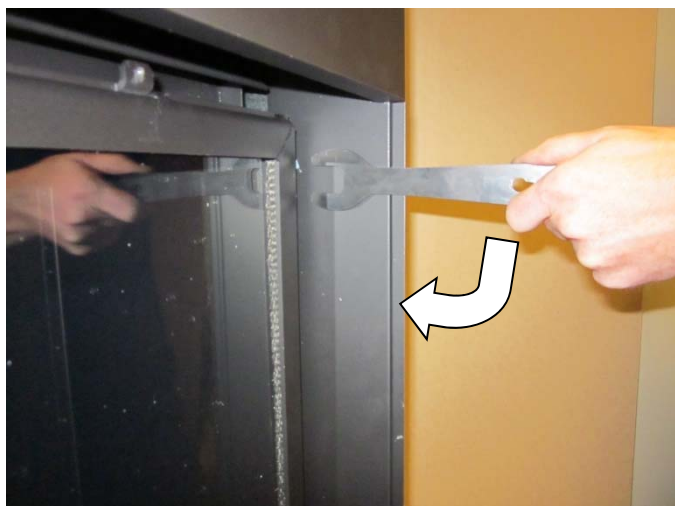

Crushed Glass Installation



Do not allow the crushed glass to block the air slots or to become too thick (maximum 1 layer deep on the burner). Failure to properly install glass may lead to sooting and improper burning.



If converting to LP (propane), convert the appliance prior to placing the crushed glass.

Install the crushed glass on the glass tray following the directions below.

Quantity of Crushed Glass	No Logs (stock)
	5 lbs. (2.2 Kg)

Before installing the crushed glass, make sure the pilot guard is in place (it is zip-tied to the glass tray – remove and discard the zip-tie). After installing the glass, remove the pilot guard. Make sure no glass covers the pilot opening.



Disperse the crushed glass evenly along the glass tray.

Make sure the two air channels are free of crushed glass. Use the glass frame tool (or screwdriver) to clear this area. **Make sure the glass is only 1 layer deep on the burner.**



Glass Cleaning

The glass may be cleaned with a non-abrasive cleaner. To clean the inside of the glass, simply remove the glass frame, place it on a non-scratching surface, and clean the surface.

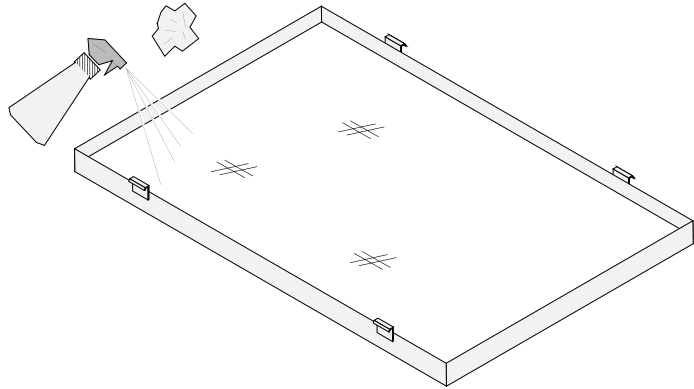

WARNING: do not operate the fireplace without the glass frame in place.

Troubleshooting Table

Problem:	Possible Cause:	Don't Call for Service Until You:
Burner Will Not Start	The battery box switch is turned to "OFF" The remote control is not working correctly..... The thermostat is disconnected or set too low..... No propane in tank.....	Turn the battery box switch to "ON". See the remote control instructions. See "Thermostat Operation". Check Tank Level.
Appliance Beeps	<u>Heater beeps once:</u> The heater beeps once whenever a button on the remote is pressed..... <u>Heater beeps twice:</u> The heater beeps twice whenever a button on the remote is pressed.....	THIS IS NORMAL The power backup batteries are low. Replace the 4 AA batteries in the battery box (see page 14).
Thermostat Does Not Work	The battery box switch is turned to "OFF" or "ON". The thermostat is set too low.....	Turn the battery box switch to "REMOTE". Check thermostat.
Blower Does Not Work	The fireplace is not getting electricity..... The fireplace is not up to temperature..... The blower fuse may be blown.....	Check the breaker switch. Let the fireplace burn for 10 minutes. Replace the fuse. See fuse location below.
Fireplace Will Not Distribute Heat	The fireplace is not getting electricity..... The fireplace is not up to temperature.....	Check the breaker switch. Let the fireplace burn for at least 15 minutes.
Flames Are Too Blue	The fireplace has just been started..... Improper air shutter adjustment.....	This is normal - see "Starting the Fireplace for the First Time". Adjust Air Shutter - contact your dealer.
Flames Are Too Short (Under 6")	The flame height may be turned too low.....	Turn the flame height to "HI" - See "Adjusting the Flame Height".
Thin Layer of Soot Covers the Glass	Crushed glass or media is placed incorrectly..... Improper air shutter adjustment.....	See "Crushed Glass Installation" page 20. Adjust air shutter - contact your dealer.
Accent Lights Do Not Work	The bulb may be burned out..... The accent light fuse may be blown.	See "Accent Light Replacement" page 17. Replace the fuse. See fuse location below.

Location of fuses

The two 3 amp fuses are on the front left of the fireplace, under the concealment cover (see page 18).

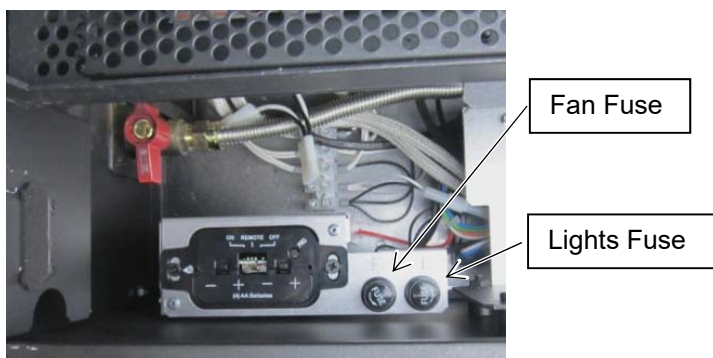

Wiring Diagram

Caution: Label all wires prior to disconnection when servicing controls. Wiring errors can cause improper and dangerous operation.

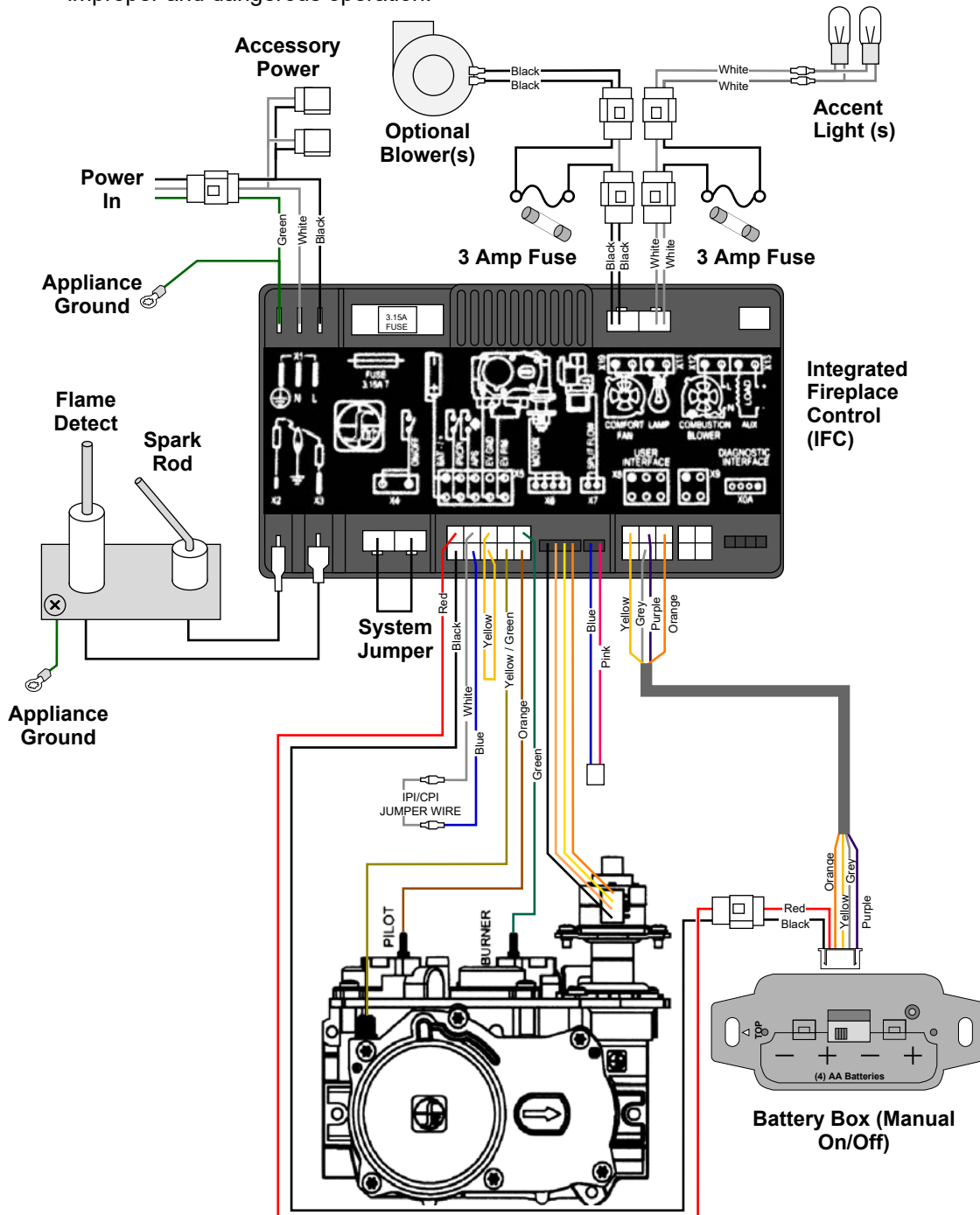

Replacement Parts List

Caution: Use only Travis Industries replacement parts. Do not use substitute materials.

Warning: Do not operate appliance with the glass front removed, cracked, or broken. Replacement of the glass should be done by a licensed or qualified service person.

Contact your local Travis dealer for a Replacement Parts List.

Register your **Dragon Wholesaling** Limited 7 Year Warranty online at lopi.com.au or complete the enclosed Warranty card and mail it within **ten (10)** days of the appliance purchase date to: Dragon Wholesaling Pty. Ltd. Unit 4, 16 Lexington Drive Bella Vista NSW 2153 Australia. **Dragon Wholesaling** warrants this gas appliance (appliance is defined as the equipment manufactured by Travis Industries, Inc.) to be defect-free in material and workmanship to the original purchaser from the date of purchase as follows:

Check with your dealer in advance for any costs to you when arranging a warranty call.
Mileage or service charges are not covered by this warranty. This charge can vary from store to store.

Component	Years 1 & 2 Parts & Labor	Years 3 Through 5 Parts & Labor	Years 6 & 7 Parts Only
Burner Assembly Burner Pan Assembly, Air Shutter Assembly, Main Burner Orifice	☑		
Electrical Assembly (within heater structure): Wiring harness, snap discs, rheostat speed control	☑		
Gas Control Assembly Adjustable control valve, fireplace controller, pilot assembly and pilot wiring	☑		
Glass Glass (breakage from thermal shock)	☑		
Ceramic Logs Log Set, Embers	☑		
Gold, Nickel & Copper Plating Face & Door (see "Conditions and Exclusions" # 9)	☑		
Accessories Firebacks, Andirons, etc.	☑		
One-Way Freight Allowance One-way freight allowance on pre-authorized repair done at factory is covered.	☑	☑	
Convection Heat Exchanger Convection heat exchanger assembly	☑	☑	
Firebox Assembly Adjustable Air Restrictor, Pressure Relief Mechanisms, Glass Attachment Mechanism	☑	☑	☑

EXCLUDED COMPONENTS:

Paint, Gasketing, and Accent Light Bulbs

CONDITIONS & EXCLUSIONS

- This new gas appliance must be installed by a qualified gas appliance technician. It must be installed, operated, and maintained at all times in accordance with the instructions in the Owner's Manual. Any alteration, willful abuse, accident, neglect, or misuse of the product shall nullify this warranty.
- This warranty is nontransferable, and is made to the ORIGINAL purchaser, provided that the purchase was made through an authorized DRAGON WHOLESALING dealer.
- Discoloration and some minor expansion, contraction, or movement of certain parts and resulting noise, is normal and not a defect and, therefore, not covered under warranty. The installer must ensure the appliance is burning as per the rating tag at the time of installation. Over-firing (operation above the listed BTU rate) of this appliance can cause serious damage and will nullify this warranty.
- The warranty, as outlined within this document, does not apply to the chimney components or other Non-Travis accessories used in conjunction with the installation of this product. If in doubt as to the extent of this warranty, contact your authorized DRAGON WHOLESALING retailer before installation.
- Dragon Wholesaling will not be responsible for inadequate performance caused by environmental conditions such as nearby trees, buildings, roof tops, wind, hills or mountains or negative pressure or other influences from mechanical systems such as furnaces, fans, clothes dryers, etc.
- This Warranty is void if:
 - The unit has been operated in atmospheres contaminated by chlorine, fluorine or other damaging chemicals.
 - The unit is subject to submersion in water or prolonged periods of dampness or condensation.
 - Any damage to the unit, combustion chamber, heat exchanger or other components due to water, or weather damage which is the result of, but not limited to, improper chimney/venting installation.
- Exclusions to this 7 Year Warranty include: injury, loss of use, damage, failure to function due to accident, negligence, misuse, improper installation, alteration or adjustment of the manufacturer's settings of components, lack of proper and regular maintenance, damage incurred while the appliance is in transit, alteration, or act of God.
- This 7 Year warranty excludes damage caused by normal wear and tear, such as paint discoloration or chipping, worn or torn gasketing, corroded or cracked logs, embers, etc. Also excluded is damage to the unit caused by abuse, improper installation, modification of the unit, drilling of the orifices, or the use of fuel other than that for which the unit is configured. Units are shipped for natural gas and must be converted to propane using the included conversion kit. Confirm fuel configuration with your installer.
- Damage to gold or nickel surfaces caused by fingerprints, scratches, melted items, or other external sources left on the gold or nickel from the use of cleaners other than denatured alcohol is not covered in this warranty.
- DRAGON WHOLESALING is free of liability for any damages caused by the appliance, as well as inconvenience expenses and materials. Incidental or consequential damages are not covered by this warranty. In some states, the exclusion of incidental or consequential damage may not apply.
- This warranty does not cover any loss or damage incurred by the use or removal of any component or apparatus to or from the gas appliance without the express written permission of DRAGON WHOLESALING and bearing a DRAGON WHOLESALING label of approval.
- Any statement or representation of DRAGON WHOLESALING products and their performance contained in DRAGON WHOLESALING advertising, packaging literature, or printed material is not part of this 7 year warranty.
- This warranty is automatically voided if the appliance's serial number has been removed or altered in any way. If the appliance is used for commercial purposes, it is excluded from this warranty.
- No dealer, distributor, or similar person has the authority to represent or warrant DRAGON WHOLESALING products beyond the terms contained within this warranty. DRAGON WHOLESALING assumes no liability for such warranties or representations.
- Dragon Wholesaling will not cover the cost of the removal or re-installation of hearths, facing, mantels, venting or other components.
- If for any reason any section of this warranty is declared invalid, the balance of the warranty remains in effect and all other clauses shall remain in effect.
- THIS 7 YEAR WARRANTY IS THE ONLY WARRANTY SUPPLIED BY DRAGON WHOLESALING, THE MANUFACTURER OF THE APPLIANCE. ALL OTHER WARRANTIES, WHETHER EXPRESS OR IMPLIED, ARE HEREBY EXPRESSLY DISCLAIMED AND PURCHASER'S RECOURSE IS EXPRESSLY LIMITED TO THE WARRANTIES SET FORTH HEREIN.**

IF WARRANTY SERVICE IS NEEDED:

- If you discover a problem that you believe is covered by this warranty, you **MUST REPORT** it to your DRAGON WHOLESALING dealer **WITHIN 30 DAYS**, giving them proof of purchase, the purchase date, and the model name and serial number.
- Dragon Wholesaling has the option of either repairing or replacing the defective component.
- If your dealer is unable to repair your appliance's defect, he may process a warranty claim through DRAGON WHOLESALING, including the name of the dealership where you purchased the appliance, a copy of your receipt showing the date of the appliance's purchase, and the serial number on your appliance. At that time, you may be asked to ship your appliance, freight charges prepaid, to DRAGON WHOLESALING. DRAGON WHOLESALING, at its option, will repair or replace, free of charge, your DRAGON WHOLESALING appliance if it is found to be defective in material or workmanship within the time frame stated within this 7 year warranty. DRAGON WHOLESALING will return your appliance, freight charges (years 1 to 5) prepaid by DRAGON WHOLESALING, to your regional distributor, or dealership.
- Check with your dealer in advance for any costs to you when arranging a warranty call. Mileage or service charges are not covered by this warranty. This charge can vary from store to store.

Index

Accent Light Replacement	17	Low Battery Indicator	13
Battery Replacement.....	14	Manual On-Off / Smart Thermostat / Standard	
Before You Begin	6	Thermostat	11
Child-Proof Feature.....	15	Mode Controls (Flame, Blower, Light)	12
Continuous/Intermittent Pilot Switch	9	Normal Operating Odors.....	15
Crushed Glass Installation	20	Normal Operating Sounds	15
Direct Operation	8	Power Outages	14
Display Fahrenheit or Celsius	13	Remote Control Warnings	6
Features	3	Remote Operation.....	10
Glass Cleaning.....	21	Remote Set-Up	7
Glass Frame Removal and Installation	18	Replacement Parts List.....	23
Heating Specifications.....	3	Starting the Heater for the First Time	8
Important Information	2	Troubleshooting Table	22
Installation Warnings.....	2	Wiring Diagram	23
Location of Controls	8	Yearly Service Procedure	16