



blaze

B400
PORTRAIT WOOD HEATER

OPERATING INSTRUCTIONS

Contemporary Styled Wood Heaters



BLAZE B400



Glen Dimplex Australia proudly supports the activities of Landcare Australia through its membership of the AHHA.

VERSION 1.0

TABLE OF CONTENTS

USER INSTRUCTIONS

1. Introduction	2
1.1. Air Controls	2
1.2. Door Handle	2
1.3. Wood Storage Compartment	2
1.4. Fan	3
2. Using Appliance for the First Time	3
3. Recommended Fuels	3
4. Lighting the Fire	3
5. Running the Appliance	4
5.1. Maximum Heat Output	4
5.2. Low Heat Output	4
5.3. Reload with More Wood	4
6. Burning Tips	4
6.1. Fuel Quality	4
6.2. Flue Draught	5
7. Ash Removal	5
8. Flue/Chimney Fire	5
9. Cleaning Paintwork and Glass	5
10. Cleaning the Flue	6
11. Troubleshooting Tips	6
11.1. Glass in Door Blackening	6
11.2. Trouble Starting the Fire	6
11.3. Door Latch Misalignment	6
11.4. Burning Too Quickly	6

MAINTENANCE AND SERVICING

1. Replacement of Fire Bricks	7
2. Replacement of Baffle Plate	7
3. Removing the Door	8
4. Adjusting the Door Hinge	8
5. Adjusting the Door Latch	9
6. Fitting a New Door Seal	9
7. Fitting New Door Glass	10
8. Change Fan Controller Frequency	10
8.1. Remote Control Receiver	10
8.2. Remote Control	10
9. Fan Replacement	11
10. Receiver Replacement	11
11. Replacement Spare Parts List	12
12. Warranty	12

User Instructions

1. INTRODUCTION

Before use of this appliance please read these instructions fully.

WARNING: ANY MODIFICATION OF THE APPLIANCE THAT HAS NOT BEEN APPROVED IN WRITING BY THE TESTING AUTHORITY IS CONSIDERED AS BREACHING AS/NZS 4013.

WARNING: DO NOT USE FLAMMABLE LIQUIDS OR AEROSOLS TO START OR REKINDLE THE FIRE.

WARNING: DO NOT USE FLAMMABLE LIQUIDS OR AEROSOLS IN THE VICINITY OF THIS APPLIANCE WHEN IT IS OPERATING.

WARNING: DO NOT STORE FUEL WITHIN HEATER INSTALLATION CLEARANCES.

WARNING: WHEN OPERATING THIS APPLIANCE AS AN OPEN FIRE USE A FIRE SCREEN.

WARNING: OPEN AIR CONTROL BEFORE OPENING DOOR.

WARNING: DO NOT BURN WOOD THAT IS PAINTED; OR IS COATED WITH PLASTIC; OR HAS BEEN TREATED WITH ANY CHEMICAL.

CAUTION: THIS APPLIANCE SHOULD NOT BE OPERATED WITH CRACKED GLASS.

CAUTION: THIS APPLIANCE SHOULD BE MAINTAINED AND OPERATED AT ALL TIMES IN ACCORDANCE WITH THESE INSTRUCTIONS.

The appliance or flue system should not be modified in any way without the written approval of the manufacturer.

Extraction fans or rangehoods must not be placed in the same room or space, as this can cause appliance to emit smoke into the room.

1.1. AIR CONTROLS

The Blaze B400 wood heater features a single air control system. It is designed to introduce oxygen into the base of the fire, controlling the rate of combustion of the wood. In addition, oxygen is drawn into the upper firebox where combustion of the gases occurs.

The air control is operated by sliding the stainless steel handle located on the top right side of the heater. Pulled all the way out offers maximum burn rate, while pushed all the way in offers minimum burn rate.

Secondary air holes in the rear of the firebox provide additional oxygen for a more complete combustion of the gases released from the burning wood.

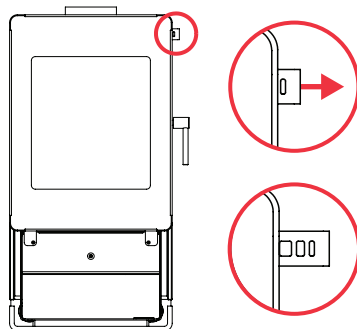

1.2. DOOR HANDLE

Warning: the door handle may get hot if appliance has been left in high burn setting for an extended period of time. Please use the provided pair of heat resistant gloves if the handle becomes hot.

1.3. WOOD STORAGE COMPARTMENT

Warning: the Blaze B400 features a storage area for a small amount of firewood. Do not overload this compartment - ensure that there is at least a 5mm gap to the ceiling of the unit.

1.4. FAN

The fan can be used to spread heat around the room quicker, as well as distribute heat into other rooms. It does not have to be on if not required.

Plug the lead from the rear of the heater into a power-point. If desired, the power lead can be rerouted to exit from the opposite side of the unit.

A remote control supplied with the heater is used to turn the fan on and determine the chosen speed.

If the radio frequency used by the remote control interferes with other frequencies in the home such as wireless internet or child monitors refer to "8. Change Fan Controller Frequency" in the Maintenance & Servicing section for details on changing the frequency.



2. USING APPLIANCE FOR THE FIRST TIME

The first few times the appliance is lit, it will give off some odorous fumes. This is caused by the paint curing.

Do not touch the paint work while it is curing otherwise it can leave a permanent mark on the appliance.

Once the paint has cured it will not re-occur.

Keep the room well ventilated until these fumes have cleared.

3. RECOMMENDED FUELS

Burn only seasoned hardwood timber with a moisture content of less than 20%. Newly cut wood should be allowed to dry/season for 12 to 18 months before use.

Wood should be stored in an environment protected from the weather to minimise any potential moisture content.

For best results, wood should not exceed 270mm in length and 150mm in diameter. Any larger, and the appliance will not operate at its optimum. It is better to burn several smaller pieces of wood than one large single piece.

Poor quality timber:

- Causes low combustion efficiency
- Produces poor emissions (smoky)
- Results in additional buildup of creosote (soot) in the flue which will then require regular cleaning and may result in a flue fire.

Do not burn painted, impregnated/treated wood, manufactured board products or pallet wood.

4. LIGHTING THE FIRE

1. Place firelighters or paper and dry kindling wood in the base of the firebox.
2. Light the paper or firelighters.
3. Open the air control located on the top right of the unit by pulling tab outwards.
4. If necessary, leave the door slightly open as the fire establishes and the glass warms to avoid the build-up of condensation.
5. Add larger pieces of wood. Too many logs may smother the fire.
6. Close the door.

Do not leave fire unattended while the door is open.

5. RUNNING THE APPLIANCE

5.1. MAXIMUM HEAT OUTPUT

After establishing the fire and loading it with larger pieces of wood, leave it running with the air slide fully open (pulled all the way out).

This setting will generate maximum heat output.

Running the appliance with the door open will not produce maximum heating in the room, as it will draw a lot of already warmed air out of the room.

Do not overload firebox with fuel.

Note that this setting is not the most energy efficient as some heat is lost up the flue instead of being transferred into the room. However, once the fire is established, particulate emissions will be very low in this setting.

To further maximise heat output, once the firebox is hot, turn the fan on to the high speed setting to spread the heat around the room.

5.2. LOW HEAT OUTPUT

The heat output of the appliance can be reduced by closing the air slide which will restrict the oxygen supplied to the fire and slow down the rate at which the wood burns.

This setting provides the best energy efficiency as the wood burns for longer. However, if not operated correctly it may worsen emissions.

Prior to closing the air slide, ensure that the fire is burning briskly. This may require opening the air slide fully for 5-10mins before shutting down.

For the optimum between clean burning and getting the best in efficiency, from the fully closed position, open the air slide 4-5mm.

The air slide can be adjusted to any position depending on desired heat output versus burn time.

Fan may be turned to low speed setting or off if the heater is putting out sufficient heat without the fan on.

5.3. RELOAD WITH MORE WOOD

1. Open air slide before opening door.
2. Rake / break up any existing coals.
3. Load the wood with the length oriented front to back.
4. Better results will be achieved by loading several smaller pieces of wood rather than one large piece.
5. Close door with air slide fully open, and leave for a minimum of 10 minutes to allow the fresh wood to catch.
6. After 10 or more minutes, the air slide can be adjusted to the desired heat output setting.

6. BURNING TIPS

6.1. FUEL QUALITY

Use wood with a moisture content of less than 20%. Logs should not feel moist or damp, or have moss and fungal growths.

Symptoms related to wet wood:

- Difficulty starting and keeping a fire burning well.
- Smoke and only small flames.
- Dirty glass and/or fire bricks.
- Rapid creosote build-up in the flue/chimney.
- Low heat output.
- Short burn times, and blue/grey smoke from the flue/chimney outlet.

Run appliance at high heat output for a short period each day to avoid large build-up of tars and creosote within the appliance and flue.

6.2. FLUE DRAUGHT

The flue has two main functions:

1. To safely remove smoke, gases and fumes from the appliance.
2. To provide a sufficient amount of draught (suction) in the appliance to ensure the fire keeps burning.

Draught is caused by the rising hot air in the flue when the fire has been lit.

The position, height and size of the flue can affect the performance of the flue draught. Refer to installation guide for details on flue installation.

Factors affecting the flue draught include:

- Insufficient flue height
- Trees or other buildings nearby causing turbulence
- High and gusty winds
- Outside temperature and weather conditions
- Blocked flue

For advice on the correction of persistent flue problems consult your supplier/installer.

7. ASH REMOVAL

Depending on the type of wood burnt and frequency, the ashes will need removing every 2 to 6 weeks.

Retaining a minimum of 10mm of ash helps protect the base of the firebox, and can make it easier to start the fire next time.

Excess ashes should be removed when necessary, placed in a non-combustible container with a tightly fitting lid and moved outdoors immediately to a location clear of combustible materials.

8. FLUE/CHIMNEY FIRE

If a flue/chimney fire occurs:

- Shut air slide control fully to smother the fire
- Do not use the appliance after a flue fire until an accredited installer has assessed the cause and any resultant damage.

9. CLEANING PAINTWORK AND GLASS

The appliance, when cool, can be cleaned with a damp cloth.

Over the years, the black paint will fade and can be touched up with Stove Bright metallic black paint.

To clean the glass, we recommend using a household window cleaner or general purpose cleaner with a soft cloth. Do not use abrasive cleaner or scourer pads.

10. CLEANING THE FLUE

Check inside of flue prior to each season for any build-up of creosote (wood tar). To do this:

1. First remove the baffle (refer to "2. Replacement of Baffle Plate" under Maintenance & Servicing section).
2. Using a small mirror and torch hold the mirror on an angle below the flue with the torch shining at it and look for black creosote build-up. A fine black powdery layer is normal, but if built up layers of creosote can be seen, then the flue needs cleaning.
3. Refit the baffle if no cleaning is required.

To clean the flue:

1. A flue cleaning brush can be purchased from most wood heater retail outlets or large hardware stores.
2. The objective is to pull the brush down through the flue.
3. With the baffle removed, tie a rope to one end of the brush, and drop the rope from the top (outside on top of the roof) down the flue.
4. Grab the end of the rope inside the firebox and pull the brush through.
5. Check the inside of the flue with the mirror and torch. Repeat if necessary.
6. Once clean, remove any excess creosote from the firebox and replace the baffle.

Check flue integrity by checking that the 900mm flue sections have not separated at the joints.

Alternatively, get a flue cleaning service to do the job for you (it's a dirty job).

11. TROUBLESHOOTING TIPS

11.1. GLASS IN DOOR BLACKENING

This can have several possible causes:

- Burning unseasoned wood — if the wood is too wet, it will cause the glass to blacken.
- Appliance operated at low temperature — after an overnight burn where the air slide control has been fully closed, the glass may have blackened. When the fire is re-stoked and burning on the high heat setting, the blackened glass should self-clean.
- Problems with the flue — insufficient flue draught can cause the glass to blacken. If the flue is too short, not properly insulated, or in a position that results in a downdraught, then there will be insufficient flue draught. Contact the installer should this happen.

11.2. TROUBLE STARTING THE FIRE

If all ash has been removed from the firebox, it can upset the supply of air to the base of the fire. When cleaning out the firebox, retaining some ash can make it easier to start the fire next time.

11.3. DOOR LATCH MISALIGNMENT

Over time the door may drop slightly, which can result in the door latch not operating smoothly. In the event that this happens, refer to "4. Adjusting the Door Hinge"

11.4. BURNING TOO QUICKLY

If you find that the heater is burning through wood too quickly, see below:

1. Latch needs adjustment (refer to "5. Adjusting the Door Latch")
2. Door seal needs replacing (refer to "6. Fitting a New Door Seal")
3. Baffle needs replacing (refer to "2. Replacement of Baffle Plate")

Maintenance and Servicing

1. REPLACEMENT OF FIRE BRICKS

The purpose of the firebricks in the appliance is to increase thermal mass and to guarantee the longevity of the steel firebox. Over time the firebricks may become cracked and crumble away. If so, they should be replaced.

To replace the firebricks:

1. Move any ash away from the bricks.
2. Remove the brick retainers and the bricks.
3. Replace with new bricks, and refit the retainers which hold the bricks in place.

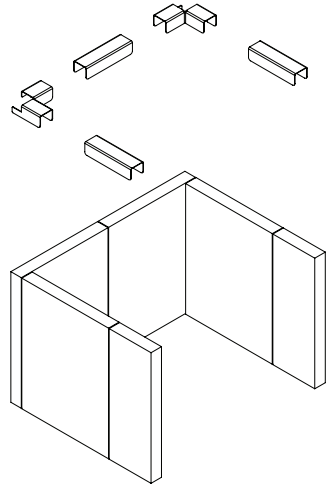

2. REPLACEMENT OF BAFFLE PLATE

The 25mm thick vermiculite baffle helps to retain heat in the firebox by lengthening the path of the flames so that they do not go straight up the flue.

Over time, the baffle may begin to deteriorate a little due to the excessive heat. This will not affect the way the fire burns.

Eventually the baffle may wear out (5+ years) and if so will need replacement. To replace the baffle:

1. Remove the front baffle retainer.
2. Shift the baffle to the right of the heater, lifting the baffle up on the right side.
3. With the right side of the baffle raised above the right baffle rail, angle the left side of the baffle downwards to clear the left baffle rail.
4. Remove baffle from heater. Ensure rear retainer is installed on new baffle. Repeat steps 1 to 3 in reverse to install new baffle.

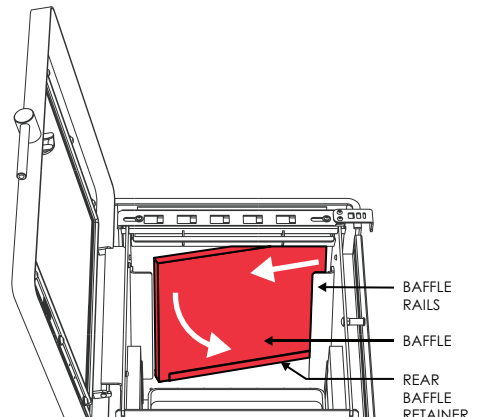
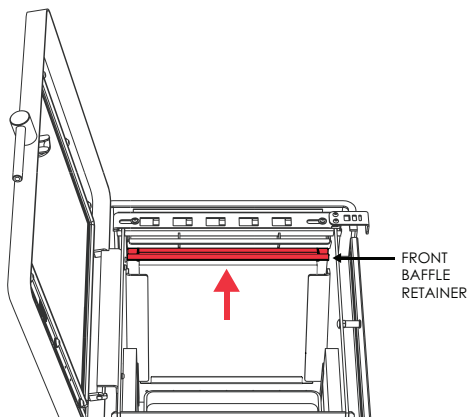

3. REMOVING THE DOOR

To remove the door:

1. Open the door all the way.
2. Lift the door up and over the top end of the vertical hinge rod.
3. Lower the door and slide off the bottom end of the hinge rod.

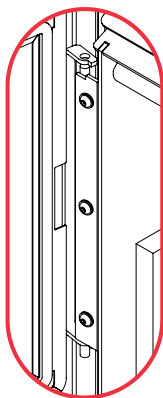
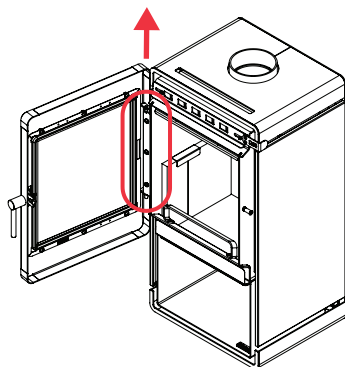

4. ADJUSTING THE DOOR HINGE

Over time the screws securing the door hinge plate to the heater may loosen resulting in the door dropping, i.e. visually appears on slight angle and no longer perfectly horizontal. This can result in poor latch feel, a loose door seal and unnecessary amounts of oxygen entering the firebox and wood burning too quickly.

To fix this and reposition the door:

1. With the supplied 5mm hex key, loosen the three screws on the hinge plate.
2. With the door 90% closed, slowly lift the bottom right corner of the door until the door is horizontal.
3. Keeping the door in that position relative to the hinge, open it and tighten the screws until firm.
4. Close the door to 90% again and make any final adjustments up or down by tapping the door on the right hand side until it appears parallel relative to the top and bottom surfaces of the heater.
5. Open door again and tighten screws fully.

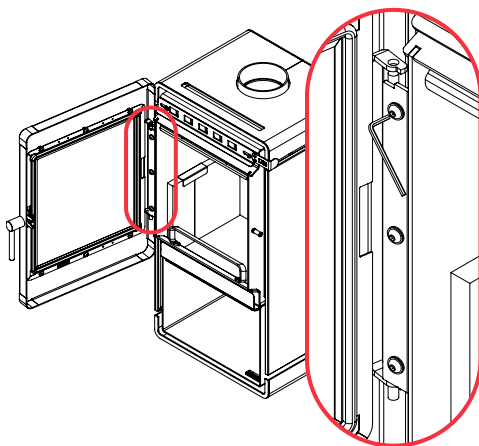

5. ADJUSTING THE DOOR LATCH

Over time, the door seal can become compressed, resulting in a less than adequate seal between the door and the front edge of the firebox. For example, if the wood burns unusually fast even with the air slide shut, it may mean that there is an air leak around the door.

In this situation, the door seal does not necessarily need replacing — adjustment of the door latch can tighten the seal.

To adjust the door latch:

1. Using the supplied 5mm hex key, loosen the M8 barrel nut.
2. Using an adjustable wrench, loosen the M8 hex nut holding the latch to the firebox.
3. Slide the latch inwards 1-2mm and retighten the M8 hex nut.
4. Close the door and test the tightness of the latch. If too tight or not tight enough, readjust until adequate latching pressure is achieved.
5. Tighten M8 barrel nut when finished.

If the door is still not latching adequately – replace the door seal.

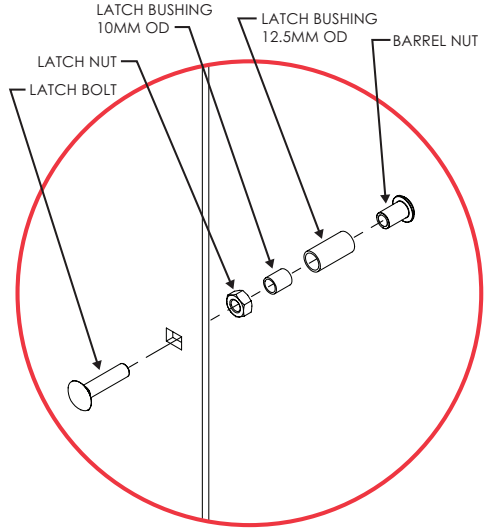

6. FITTING A NEW DOOR SEAL

This task may be easier with the door removed from the heater and laid flat on a workbench.

1. Remove any old seal from the door.
2. Clean out the groove in the door that the seal was bedded in using a flat-end screw driver or equivalent.
3. Run a thin bead of clear roof and gutter silicone along the groove.
4. Starting at one end, press the new door seal into the groove on the door.
5. Refit the door if it has been removed.

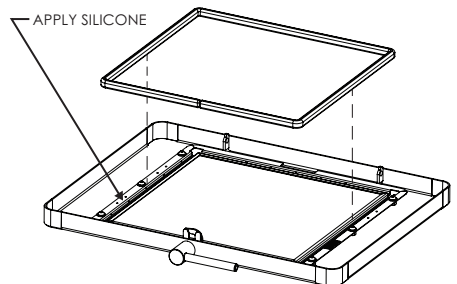
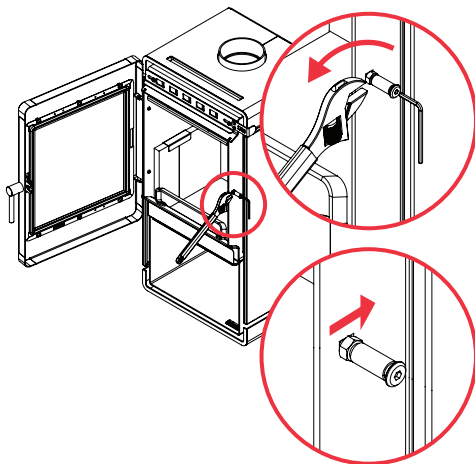

7. FITTING NEW DOOR GLASS

This task may be easier with the door removed from the heater and laid flat on a work-bench.

To replace the door glass:

1. Remove the six M8 button head screws and twelve washers securing the glass retainer to the door with the supplied 5mm hex key.

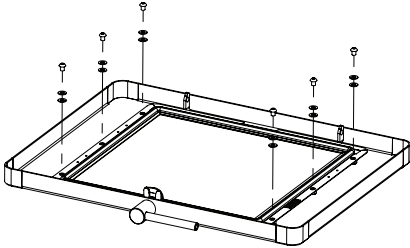

2. Gently lift the glass retainer up and out, taking careful note that the glass may still be held in the retainer and could fall out.

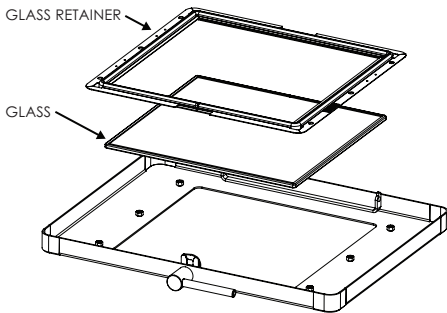

3. Flip the retainer over, remove the old glass.
4. The new door glass panel should have been supplied with a length of adhesive glass seal. Peel back the backing on the tape, and run it along the edges of the glass panel, folding it equally over each side so as to create a padded border around the edge of the glass.
5. Fit the new glass into the glass retainer, relocate the retainer so that all six threads can be seen through the holes, before fastening the six screws.

8. CHANGE FAN CONTROLLER FREQUENCY

The frequency used by the fan remote control can be changed if interferences are experienced in the home.

Unplug the power lead before proceeding.

8.1. REMOTE CONTROL RECEIVER

The remote control receiver has four small switches on the side, as seen in the photo below. Change the switch setting to something different than current setting. Remember this switch setting as it will need to be replicated on the remote.



To access the remote control receiver:

Using the supplied 4mm hex key - remove the receiver box that is held in place with two button head screws in the rear of the wood box.

8.2. REMOTE CONTROL

Remove the battery cover and batteries. With a small screwdriver or equivalent, change the switch setting to be the same as that on the remote control receiver.

Replace the batteries and cover, plug in the power lead and test the fan with the different frequency setting. If interferences are still experienced, repeat the steps with another switch setting configuration.

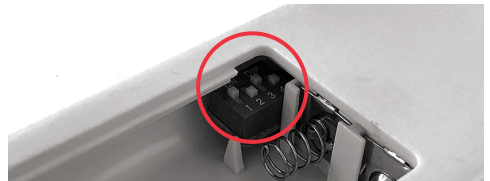

9. FAN REPLACEMENT

Over the life of the heater, the fan may fail or become less efficient. In the event that the fan fails, it will need to be replaced.

Unplug the power lead before proceeding.

To replace the fan:

- Using the 8mm hex key supplied with the replacement fan – remove the M12 button head screw holding the fan in place.

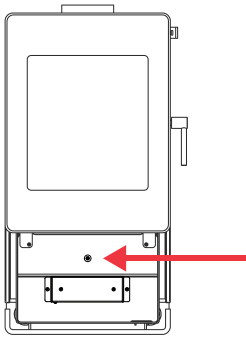

- Slide the fan assembly outwards from the rear of the heater. When out, unplug the cable to disconnect the fan.

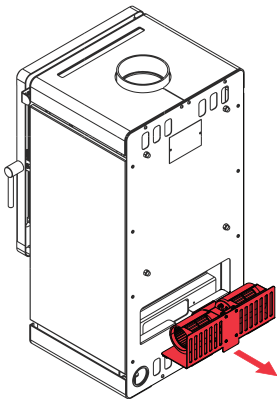

- Connect replacement fan cable. Slide the new fan assembly in from the rear of the heater, guiding the cables into the centre.
- Secure fan with M12 screw from step 1.

10. RECEIVER REPLACEMENT

Over the life of the heater, the fan receiver may fail. If this occurs, it will need to be replaced.

Unplug the power lead before proceeding.

To replace the fan receiver:

- Using the supplied 4mm hex key - remove the two M6 button head screws holding the receiver box in place.

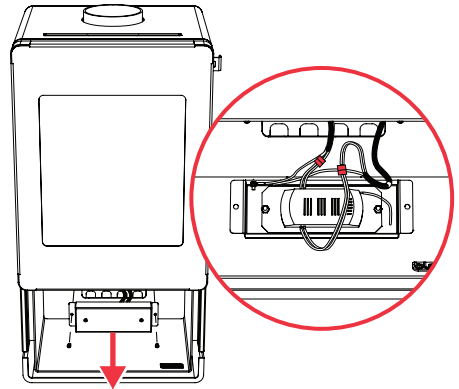

- Unplug the two plugs to the receiver.
- Undo the two M6 hex nuts holding the receiver plate to the receiver box.
- Reinstall the new receiver by repeating steps 1-3 in reverse.

11. REPLACEMENT SPARE PARTS LIST

PART	DETAIL
Fire Bricks	4 @ 270 x 207 x 25mm
	2 @ 270 x 100 x 25mm
Brick Retainers	3 X stainless brick retainer straight, 2 X corner
Baffle Plate Kit	365mm x 278mm x 25mm vermiculite, matching front and rear retainers
Door Seal	1720mm x 16mm round
Glass Seal	1690mm x 19mm x 3mm flat adhesive backed
Door Glass	405mm x 439.5mm x 5mm Robax
Latch Bolt (refer page 9)	M8 x 35mm coach
Latch Bushing (refer page 9)	10mm OD x 12mm stainless
	12.5mm OD x 26.5mm stainless
Barrel Nut (refer page 9)	M8 x 15mm
Latch Nut (refer page 9)	M8 x 6.5mm hex
Door Handle	M8 threaded
Door Handle Hook	4mm plate
Door Handle Nut	M8 prevailing torque
Door Handle Washer	M8 spring
Log Guard	332mm x 60mm x 5mm
Fan	3 speed
Fan Remote Receiver	3 speed
Fan Remote Control	3 speed

12. WARRANTY

Glen Dimplex Australia Pty. Ltd. warrants this stove to be able to operate under normal use and service and within 10 years from the date of the original purchase on the terms herein shall repair or replace without cost to the original customer any part thereof which shall be returned to our factory, transportation charges prepaid and which our inspection shows would prevent operation.

This warranty does not apply to firebricks, brick retainer, baffle, door seal, glass, nor discolouration of the surface or tarnishing of chrome fittings all of which require normal service to maintain them.

Under the terms of this warranty, Glen Dimplex Australia Pty. Ltd. assumes no responsibility for the labour costs involved in removing or replacing the stove. Nor shall Glen Dimplex Australia Pty. Ltd. be liable for any injury, loss, or damage (direct, indirect or consequential) arising out of the use or inability to use the product, or its removal and replacement. All other stove warranties, expressed or implied are excluded to the extent possible to law. Any claims against Glen Dimplex Australia Pty. Ltd. must be brought within Australian Jurisdiction.

Electric fans and any remote sender or transmitter are warranted against failure to operate for a period of 1 (one) year from original purchase date.

The Retailer does not have the authority to alter this warranty



Glen Dimplex Australia Pty Ltd

8 Lakeview Drive,
Scoresby Victoria 3179
Australia

T: 1300 556 816 | F: 1800 058 900

General & Sales Enquiries: flame@glendimplex.com.au

Technical Service: service@glendimplex.com.au

www.glendimplex.com.au